

POWERboat Design

*Function and form,
and their effects on performance*

Text and designs by Tad Roberts

Wander around any boatyard and have a look at the powerboats. The shapes and styles seem endless: short, wide, and deep; long, lean, and shallow; round, veed, or flat bottoms; stems vertical or raked; and sterns of every conceivable form. Usually, each of these features has a reason for being that may be obvious or obscure.

Consider a low-slung deep-V hull. With twin outdrives and wild graphics, she is obviously built for speed. But what about the older, round-bottomed cruiser? With upright, conservative good looks and wineglass sections, how fast will she go? Only 8 knots? Why? And what about the V-bottomed speedboat in the Travelift that just lost a buyer because she would go only 18 knots? She looks fast; what's the problem? Weight? Power? Shape? Each boat, by its style and form, makes a promise regarding performance. And each of us is excited by a different promise.

All this diversity is the magic of boats; no one boat is perfect for every use. Part of this is manifested in configuration. For example, sport fishermen need a large cockpit; liveaboards do not. But it is also because only one hull shape is right for a particular loading and speed. The sport fisherman is in a hurry, and he wants to take a lot of equipment with him, so he has a wide, shallow, V-hull to plane his fishing gear, massive engines, and tons of fuel across the top of the water. The liveaboards are typically not in a hurry; for economy they make do with the smallest possible engine to move their home. And their home's hull is optimally shaped to take advantage of that minimal power.

In this article I'll explore a series of powerboat designs, discuss the reasoning behind their various features, and look at the effects of these features on performance. This is mostly about hull shape and behavior, not about layouts (though decisions regarding performance and weight and space requirements for tankage will ultimately affect the arrangement).

Before looking at the designs on the following pages, however, you should be familiar with some design measurements, ratios, and rules. These help greatly in evaluating and comparing designs on paper.

Speed/Length (S/√L) Ratio

Powerboat designs are loosely categorized into three groups: displacement, semi-displacement, and planing hulls. These groupings refer to a boat's power in relation to its weight, and therefore a particular hull's speed capability. We assign a numerical value to this speed capability in several ways. One simple method is the speed/length ratio, which is speed in knots divided by the square root of the waterline length. Speed/length ratios for boats in this article range from ALDER's 1.25 to MAHOGANY's 12.5.

A speed/length ratio (S/√L) of 1.34 is generally assumed to be the limit for displacement hulls, and is called "hull speed." As speed increases beyond a S/√L of 1.34, the stern wave is left behind and the boat's stern squats and her bow rises as she tries to climb the back of the bow wave. Wavemaking resistance increases very rapidly when S/√L increases beyond 1.34, but it is not a stone wall; given sufficient power, a displacement hull can certainly be pushed up to a S/√L of 1.5 or 1.6. But this is considered semi-displacement territory, and a different hull form is in order.

Displacement/Length (D/L) Ratio

A second simple way of comparing powerboats is the displacement/length ratio.

$$D/L = \frac{\text{Displacement in long tons (1 long ton = 2,240 lbs)}}{(.01 \text{ LWL})^3}$$

In the following series of boats, D/Ls range from YELLOW CEDAR's low of 125 to IRONBARK's high of 416. It's interesting that the lowest and highest are both displacement boats (I planned it that way!). So, D/Ls don't necessarily tell us much about a boat's actual speed. But a D/L of 250 or more means a boat is getting too heavy to plane efficiently, though it may well be a semi-displacement boat. A D/L of 125 means a boat has proportionately small engines and fuel load, is lightly built or has a high-tech structure, and if it is a planing boat it won't get far. D/Ls of the planing boats range from 141 to 226.

One interesting thing D/L tells us about is wavemaking.

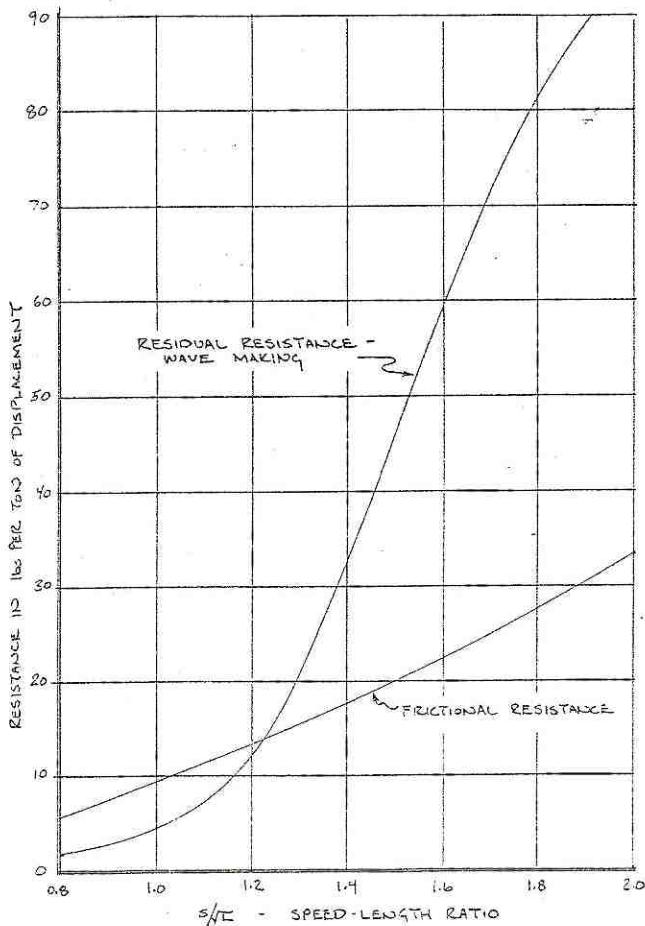

Resistance as a function of S/\sqrt{L} .

hull form, air resistance, eddymaking, and appendage drag.

At a very low S/\sqrt{L} , resistance is mostly frictional. But as speed increases above a S/\sqrt{L} of about 1, residual resistance increases rapidly. At displacement-boat cruising speed ($S/\sqrt{L} = 1.34$), total resistance is comprised of about half frictional and half residual. Beyond this S/\sqrt{L} , residual resistance for a heavy-displacement boat increases dramatically, going almost straight up along a speed scale; frictional resistance, on the other hand, continues a gentle increase with speed (see graphs above).

As discussed above, hulls having lower D/L s create smaller waves at any speed, so their residual resistance curve will be flatter. Weight is, therefore, a major factor in performance, and weight compared to power will be one of the most important criteria we look at throughout this article.

How Much Power Is Enough?

There are many methods of estimating required power for a design, from crude rules of thumb to very precise tank tests. One of the simplest rules of thumb is for displacement boats; one installed horsepower for every 500–600 lbs of boat will give you a S/\sqrt{L} of 1.34, with some reserve. It takes about twice this, one horsepower for every 250 lbs of boat, to get a little above $S/\sqrt{L} = 1.5$ with a displacement hull. Predicting power requirements for anything above displacement speeds becomes more complex.

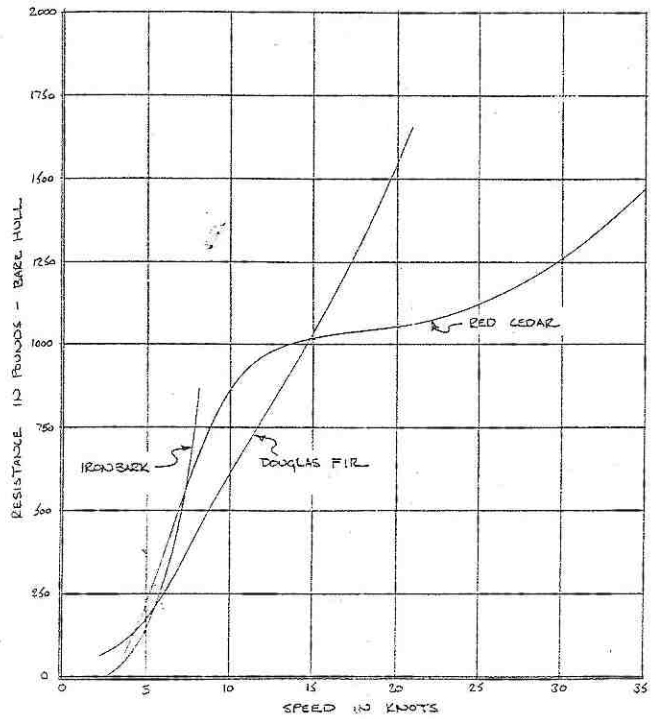

Resistance curves for IRONBARK (displacement), DOUGLAS FIR (semi-displacement) and RED CEDAR (planing).

The Crouch Constant

In the 1930s, designer George Crouch came up with a formula to predict either power or speed for semi-displacement or planing hulls. This formula accounts for differences in hull form and drive efficiencies through the use of a constant derived from similar boats. In various forms this formula is still in general use and is quite accurate if care is taken to find solid data on similar hulls and average the constant between them. Crouch's formula works as follows:

- C = Crouch constant
- V = Speed in mph (knots $\times 1.1516$)
- W = Weight of vessel in pounds
- P = Shaft horsepower

The basic formula is:

$$V = \frac{C}{(W \div P)^{1/2}}$$

transposed to solve for horsepower:

$$P = W(V \div C)^2$$

or, to find the constant:

$$C = \frac{V}{(P \div W)^{1/2}}$$

Constants range from about 140 for small runabouts to 260–270 for large cruisers.

Beyond this there are numerous other calculation methods, very complex formulas using test data from various model series, computer prediction software, and finally, tank-testing a model of the hull itself.

200 inq
 80 x inq
 19/5 inq
 CIB225
 B/T 4110

Displacement Hull

ALDER

LOA	18'
LWL	16'8"
Beam	6'8"
Draft	19 1/2"
Displacement	2,450 lbs
D/L	236
Power	Volvo Penta MD1
	7 hp
Cruising speed	5 knots
S/L	1.22
FN	.81
C _p	.59
B. L.	.37

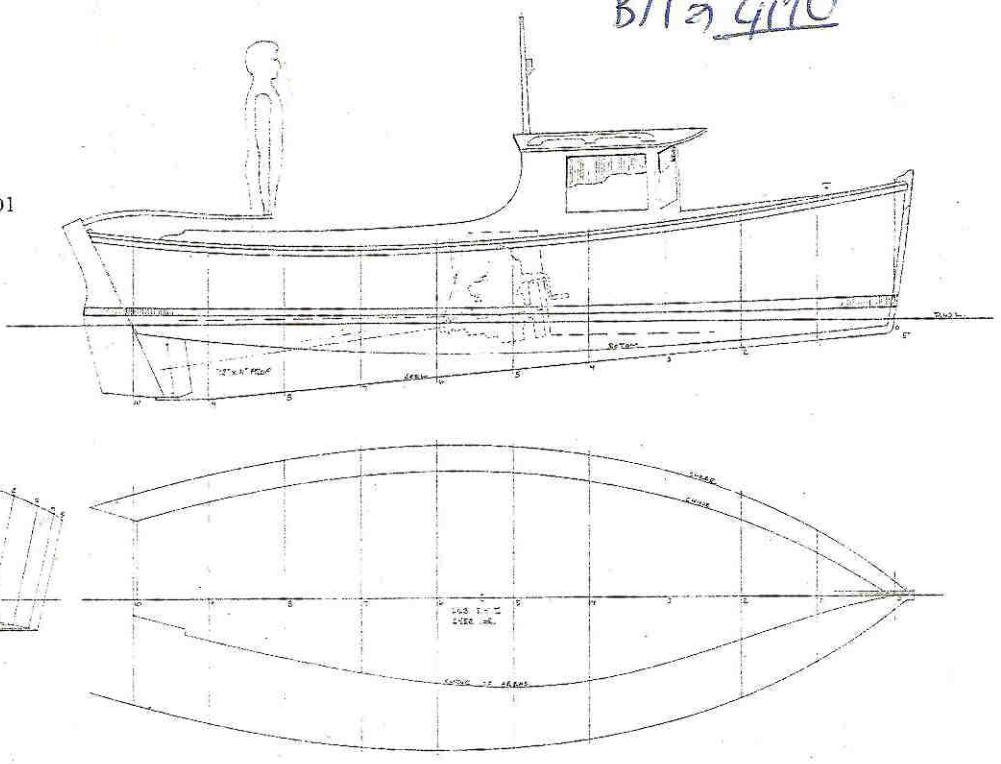

With the above factors in mind, I'll turn now to a series of designs I have drawn especially for this article to illustrate the variety of performance characteristics in powerboats. You will probably note here my bias—a plea for what, in his book *Yacht Designs II*, William Garden calls "more boat-shaped boats." Maximum interior volume and raked black glass have been discarded in favor of side decks one can actually walk on; upright windows one can see through; and, in general, heavy, slow-revving machinery.

ALDER

ALDER is an 18' flat-bottomed displacement boat. At a S/L of 1.22, her cruising speed is 5 knots, so the owner will be a patient soul more interested in spending time on the water than in getting someplace fast. This type of boat is ideal as a harbor cruiser, inshore fisherman, or island support boat. Of simple construction, she has a moderate initial cost, and her operating budget is tiny.

Using the rule of thumb of 1 hp to every 500 lbs, ALDER needs about 5 hp to attain her cruising speed. I have selected the 290-lb, 35-year-old Volvo Penta MD 1 diesel, producing 7 hp at 2,300 rpm. Why all this engine when a 75-lb, 15-hp outboard would do just fine? First, the Volvo produces 5 hp at only 1,500 rpm, which is so much easier to listen to than the outboard's 4,500-or-so rpm. But the outboard is much smoother, you say. This is true, but I can work on the Volvo with a hammer and a couple of metric wrenches. When the outboard throws a fit, I must take it to the nearest factory-trained technician. Besides, the Volvo's slow, steady, thump is appropriate to ALDER, and the weight will steady her.

Obviously, a number of different propulsion units will fit the bill. But remember, these are pleasure boats, and the engine is part of the pleasure. As a designer, I'm rarely cold and calculating when it comes to engine selection.

ALDER, at 4 knots, has no need of flaring bow sections because her bow wave is relatively tiny and the spray thrown because of her speed is minimal. The chance of her being caught out and having to buck a steep sea home is small, but if such a situation did arise, her tiny power would provide little headway, and the proper tactic would be to put her stern to it and run off downwind to some shelter.

ALDER has no need of sleek aerodynamic styling, because air resistance is a minor fraction of her overall resistance. Since, for a given power and weight, the longest waterline will produce the highest speed and, therefore, the most miles per gallon of fuel, the most efficient shape for ALDER would be vertical stem and sternposts with no overhangs. But, look at the speeds more closely: hull speed for ALDER's 16'8" waterline is 5.47 knots, while her hull speed with no overhangs and a waterline of 18' will be 5.68 knots—a difference of .21 knots, a gain of 4%, at what is probably her top speed. This would be a very big deal if ALDER were crossing oceans, but since she is just going down the harbor, whether we go at 5.5 or 5.7 knots matters little when balanced against the designer's aesthetic requirement that his boat be beautiful in the traditional sense.

In creating a shapely, graceful hull with sheet material, the best way to start is by raking the ends and putting flare in the sides. ALDER's hull is essentially a big skiff with some of a dory's grace pulled into her topsides. Of course, she will bob underfoot when you step on the rail, but, again, one of my underlying requirements is she

Displacement Hull

IRONBARK

LOA	28'
LWL	25'10"
Beam	9'10"
Draft	3'8"
Displacement	16,250 lbs
D/L	421
Power	Perkins 4-236
	62 hp
Cruising speed	6.8 knots
S/\sqrt{L}	1.34
$FN\triangleright$.8
C_p	.599
B/L	.35

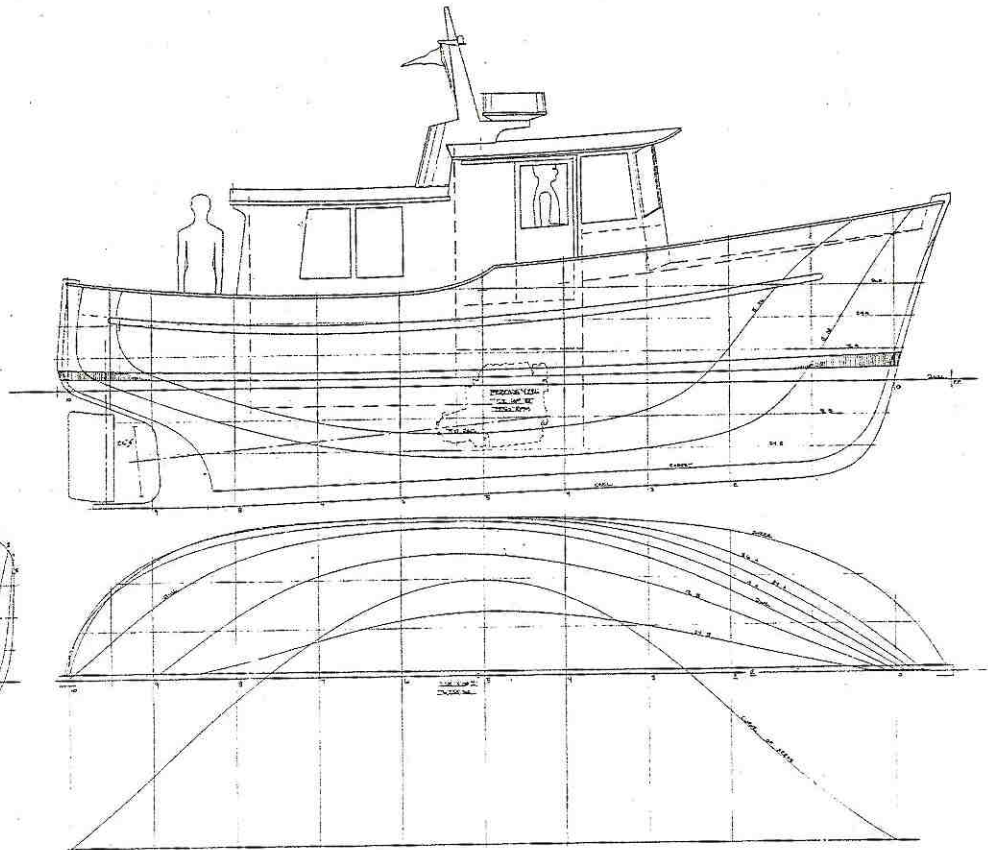
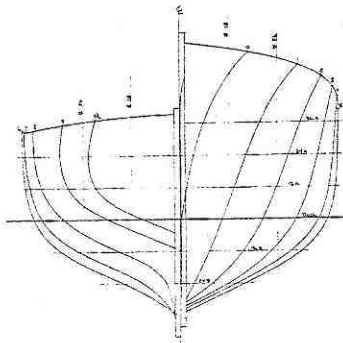

should look as little like a box as possible commensurate with her plywood construction. The next step in trying to transform her boxiness would be to rip the plywood into wide planks and lapstrake-plank her topsides. With the upper strake painted white and the rest a soft gray, ALDER would look the proper little ship.

The flat bottom makes perfect sense for this little boat. Its apparent simplicity inspires confidence in the home builder, and the crude shape is not disastrous at ALDER's operating speed. Resistance up to a S/\sqrt{L} of about 1.0 is mostly frictional, and therefore dependent on wetted surface. Of course, shape makes some difference; the hard chine produces drag in the form of eddymaking, and arc-shaped sections would have less wetted surface than these rectangles for the same displacement.

IRONBARK

Though actually not a very large boat, IRONBARK will have the feel of one. Her slow, deep roll, straight tracking, and ability to keep on going no matter what, are the benefits reaped from plenty of weight, a long, straight keel, and fine, deep sections. She is very much a traditional type; her lineage started before 600 A.D.

with Norse Viking ships, came through Scandinavian and Irish fishing vessels, and finally showed up in the fishing boats of Canada's west coast—my home waters.

Her looks are also entirely in keeping with her performance; there are no tricks here. The deckhouse and accommodation are very limited for her weight and cost. A large deckhouse can visually overpower a graceful hull; get the proportions wrong, and the boat starts to look top-heavy.

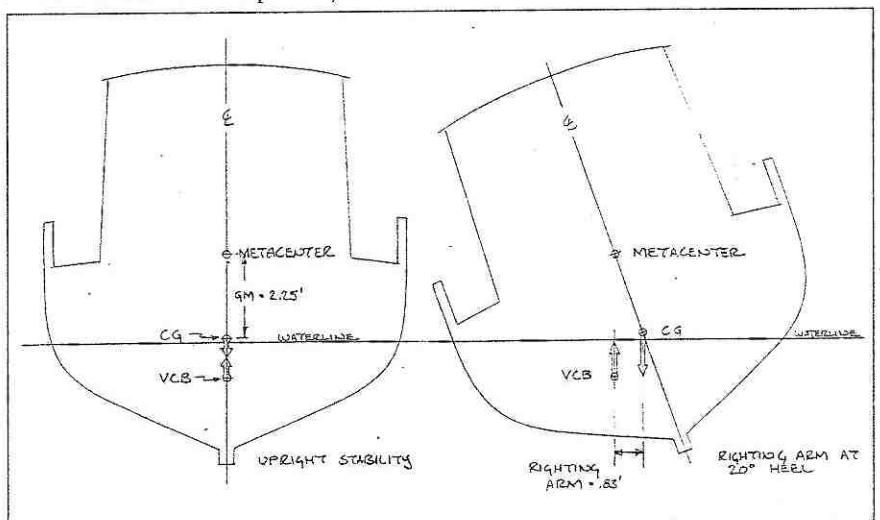

Stability terms. As the boat heels, VCB moves outboard of CG, creating a righting arm.

455 in,
20
32

L/B₂ 3,80
B/T₂ 3,75

Displacement Hull

YELLOW CEDAR

LOA	38'
LWL	37' 11"
Beam	10'
Draft	2' 8"
Displacement @ 1/2 load	15,000 lbs
Fuel	100 gallons
D/L	125
Power	Perkins M30
	28 hp
Top speed	8 knots
S/√L	1.3
FN _∇	.96
D/L	125
C _p	.592
B/L	.25

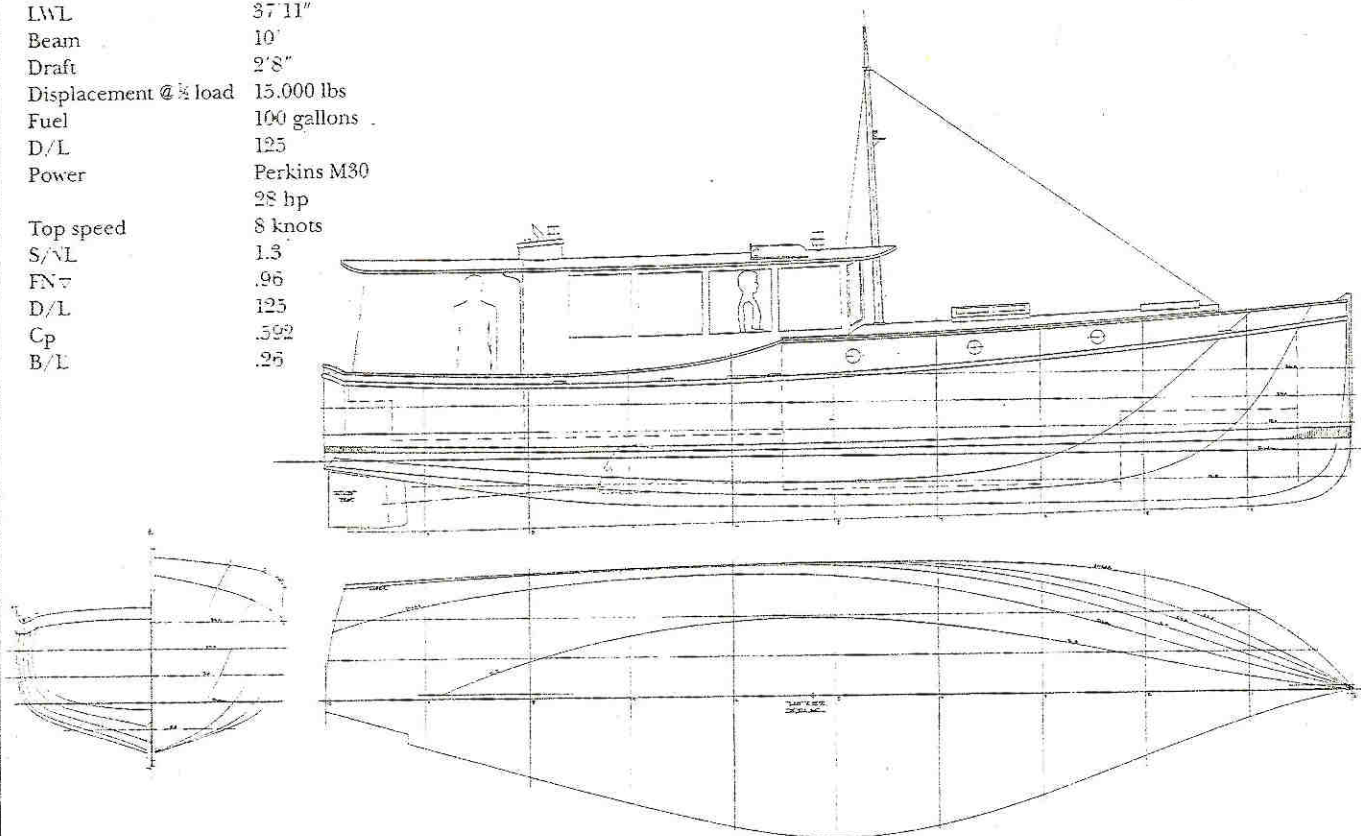

Is the double-ended hull more seaworthy? There is much more to seaworthiness than stern shape (I'll discuss this further in the comments on DOUGLAS FIR, page 84). However, the double-ended form will be less likely than one with a large, flat transom to get pushed around by big seas when running off before the wind. But the rest of the hull, with her deep forefoot and long, straight keel, will cause her to roll terrifically and require much work on the helm when running. Better to tack into it, or fit stabilizer poles and flopper-stoppers; she'll ride like a duck along the trough of a big sea with the stabilizers out.

Look at her curve of areas. The double-ended form takes hull volume down to zero at station No. 10, meaning there will be zero drag from such a stern. That's just what's needed in a hull that won't run any faster than S/√L 1.34 or 6.8 knots. The double-ended form is also a particularly handsome way to end a boat.

I have drawn in the Perkins 4-236 as power for IRONBARK. This engine produces 62 hp continuous at 2,250 rpm. Using our rule of thumb for displacement hulls, IRONBARK needs only 32 hp to achieve a S/√L of 1.34 or 6.8 knots, so she'll cruise at only 1,400 rpm with plenty of power in reserve.

IRONBARK carries 2,600 lbs of ballast in the form of lead pigs down on top of the keel between the floors. Ballast? In a powerboat? Why? Because it lowers VCG (vertical

center of gravity) and lengthens the GM. GM is the distance from the CG to the metacenter. The metacenter's height is dependent on waterplane inertia: A narrow, fine waterplane gives a low metacentric height and a rolly boat; a wide, full waterplane gives a high metacenter and a stiff boat. As the boat heels, the VCB (vertical center of buoyancy) moves about the metacenter, and produces a righting arm (defined as the horizontal distance between a vertical line connecting VCB and metacenter, and CG. The longer the GM, the faster a large righting arm is developed, and the faster the boat returns to upright. There is no real agreement on how much GM is enough. Francis S. Kinney, in *Skene's Elements of Yacht Design*, mentions a GM of 2' to 2'6" for small power cruisers. IRONBARK is right in the middle of that with a GM of 2.25'. The VCG 2" above DWL allows for additions of weight up high, a heavier mast and stabilizer poles, or a dinghy on the cabintop.

YELLOW CEDAR

YELLOW CEDAR is a minimum-powered cruiser reminiscent of an earlier time. The vertical stem and stern are functional and not a retro styling attempt. In her role as a liveaboard home for a retired couple, the vertical ends provide the most interior space for her length because liveable volume is dependent on waterline length. Yes, she would look lovely with a fantail stern or maybe as a

Semi-displacement Hull

OAK

LOA	18'
LWL	17'1"
Beam	7'
Draft	2'3"
Displacement @ 1/2 load	34,00 lbs
Fuel	40 gallons
D/L	304
Power	Perkins M30 28 hp
Top speed	9 knots
S/√L	2.2
FN∇	1.37
C _p	.702
B/L	.39

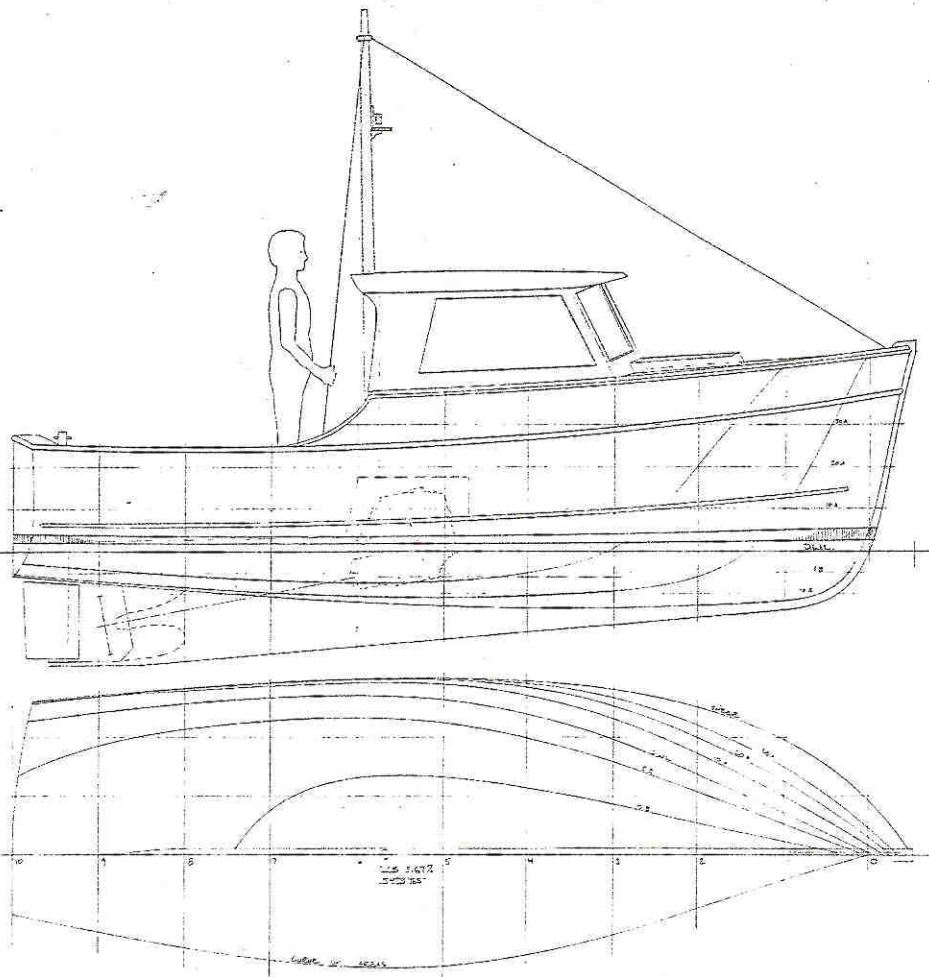

double-ender, but either would ruin the roomy cockpit/back porch that the wide transom provides. The transom stern also picks up buoyancy quickly as it sinks, limiting the tendency to squat.

She is small for her length; her B/L (.263) is the lowest of the group. Coupled with minimum freeboard, she has a small cross-sectional area and thus the lowest D/L (125) in the group.

Long, light boats are easy to push; with proper hull form, they are easy to push fast, or, as in this case, easy to push at moderate speed with very little power. Though possibly a candidate for a hybrid electric/diesel generator drive, I've stuck to the conventional and drawn in a Perkins M30 that produces 28 hp at 3,600 rpm. But what about our 500 lbs per horsepower? Doesn't YELLOW CEDAR, weighing 15,000 lbs, need 30 hp? YELLOW CEDAR is a minimum-power cruiser with a very light D/L, and if we back off the speed a little, things look pretty good. For a S/√L of 1.2, or 7.5 knots, we only need 21 hp, which is 2,200 rpm on the engine. Or if we drop down to a S/√L of 1.1, or 6.8 knots, we only need 16.5 hp, which is about 1,900 rpm—an ideal cruising speed with fuel consumption of about .9 gallon per hour.

In 1928, YELLOW CEDAR would have been equipped with an 8-hp, four-cycle, gasoline engine. "Those old engines produced real horses, not the ponies we get from

these new things," is a statement often heard around the docks. The reason for this is the law of torque (twisting power):

$$\text{Torque} = \frac{5,252 \div \text{hp}}{\text{rpm}}$$

Maximum rpm for the old 8-hp engine was 600, producing 70 lb-ft of torque. The modern engine puts out 28 hp at 3,600 rpm, and 40 lb-ft of torque. But we fit a reduction gear of 2.4:1 and get 98 lb-ft of torque, which will turn a 16 × 13" three-bladed propeller. The old engine was direct drive with no reduction gear, and turned an 18 × 13" two-bladed prop. This would give YELLOW CEDAR a speed of about 7 knots in calm water, with no reserve power for adverse tide or weather. Old-timers spent many hours hiding behind a point of land, waiting for the tide to turn or the wind to go down. Now, when we leave the dock, we have a schedule to keep, and large power reserves (in the order of 30–50%) are considered mandatory.

OAK

OAK is a semi-displacement boat, styled after the type known in the British Isles as an "Inshore Fisherman." A semi-displacement boat is faster than a pure displacement boat of the same waterline length, but why?

The engine for OAK is the same as that of YELLOW

Semi-displacement Hull

DOUGLAS FIR

LOA	28'
LWL	26'8"
Beam	10'6"
Draft	2'9"
Displacement @ ½ load	11,600 lbs
D/L	273
Power	Twin Yanmar 4LH-DTEs 170 hp (each)
Top speed	20 knots
S/√L	3.87
FN _∇	2.49
C _p	.694
B/L	.37

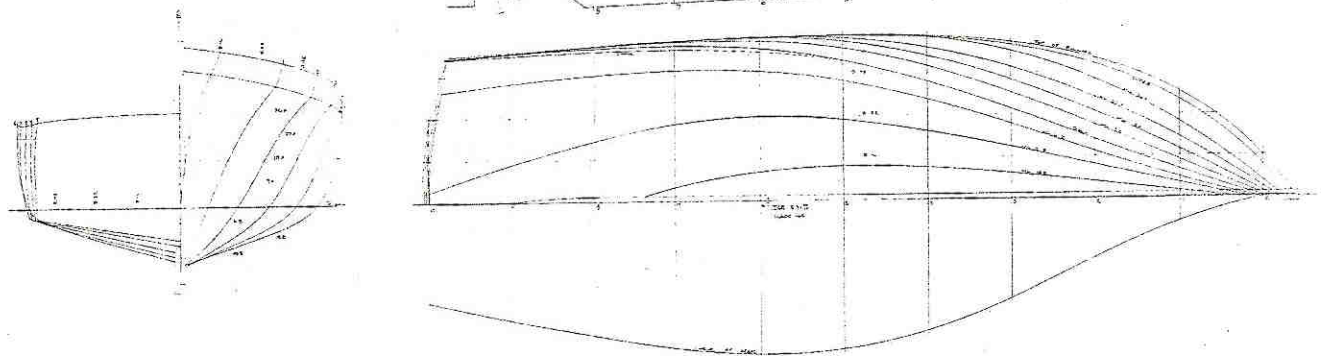

CEDAR, the 28-hp Perkins, but with a 1.4:1 reduction gear. With this power, OAK will run up to a S/√L of 2.2, or FN_∇ of 1.37, which is 9 knots. She is faster than ALDER even though she's heavier, mostly because of an increase in her power/weight ratio. ALDER has 1 hp for every 350 lbs of boat, while OAK has 1 hp for every 135 lbs of boat— or two-and-a-half times the power!

There are also subtle changes in hull form for the faster boat. Look at OAK's curve of areas and compare it to that of ALDER. You can see OAK is much fuller aft and her LCB is at station 5.65, whereas that of ALDER is at station 5.4. Again, we come to looking at sterns. Note OAK's transom immersion. For her S/√L of 2.2, the immersed area at the transom needs to be about 45% of the area of station No. 6. These broad quarters keep the stern up as she gets going and begins to leave the stern wave behind.

OAK is also about 1,000 lbs heavier than ALDER, due to increases in beam and freeboard. OAK's higher speed means heavier construction to handle increased dynamic loads, larger engine, and larger fuel load.

With increased freeboard, speed, and reserve power, OAK has considerably more capability than ALDER, but at greatly increased cost. Can this cost be justified? For the fisherman, more speed means more spots tried each day and increased profits. As a pleasure boat, OAK can maintain her speed in adverse weather, so you can get home even when the wind blows—vital in today's world.

DOUGLAS FIR

DOUGLAS FIR is a boat that truly can "carry on regardless"; I'm sure the crew will give up before she does. I was thinking of a pilot boat when I first sketched her, thus the quasi-commercial styling. TEAK is the only boat in the group to approach her in seaworthiness, but DOUGLAS FIR will maintain 18 knots when TEAK will have to slow down because of pounding.

With a deep, rounded forefoot evolving into hard-chined shallow V sections aft, she is a real hybrid. The fastest in this group of semi-displacement hulls, the V sections will semi-plane the stern, provide dynamic lift, and improve trim. Some people are of the opinion that a boat this wide is no good running in a big sea, but I think rudder size may have as much to do with it as anything. Many fast boats are equipped with tiny rudders to reduce drag, but they also reduce turning moments. DOUGLAS FIR has two oversized rudders. It's a balancing act getting a hull that's optimum in many conditions at high speed, trading weight and section shape against LCB location.

Is she seaworthy? The design is as able as I can make it, but seaworthiness involves more than just hull shape. Construction must be good, equipment must be well made and maintained, and the crew must be competent. As far as design goes, a seaworthy boat includes adequate freeboard, reasonable beam and draft (not too much beam and enough draft to get heavy weights down low), watertightness, and stability (low VCG). Safety equipment, watertight bulkheads, and decent visibility under difficult

Semi-displacement Hull

WHITE PINE

LOA	38'
LWL	36'3"
Beam	12'7"
Draft	3'10"
Displacement	21,000 lbs
D/L	197
Power	Volvo TAMD 63L 305 hp
Top speed	15 knots
S/ \sqrt{L}	2.49
FN ∇	1.7
C _p	.69
B/L	.33

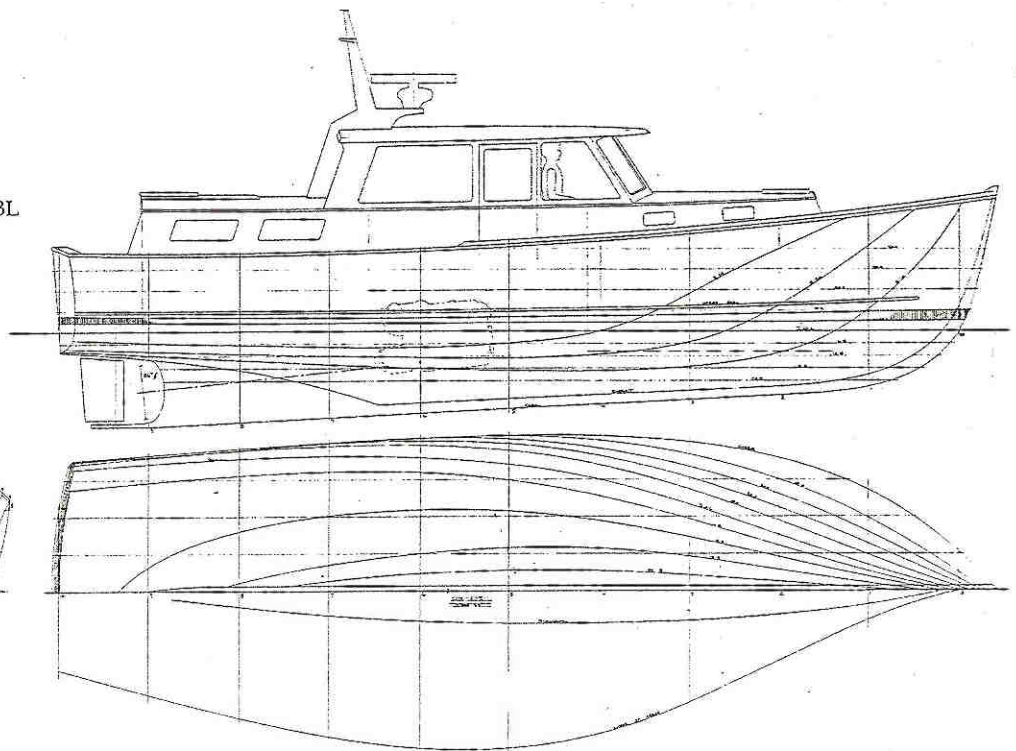
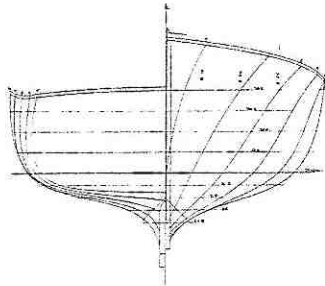

conditions all help boost seaworthiness, as well.

Power for DOUGLAS FIR is twin diesels—Yanmar 4LH-DTEs—producing 170 hp at 3,300 rpm each for a total of 340 hp. That's 34.4 lbs/hp. So at her top speed of 20 knots, $S/\sqrt{L} = 3.87$, she will burn about 18 gallons of diesel fuel per hour. It's interesting to compare this performance with DOUGLAS FIR's planing counterpart, RED CEDAR. To make 20 knots, RED CEDAR needs only about 160 hp—49 lbs/hp—which burns about 16 gallons of gas per hour. This amounts to slightly less fuel burned per hour, for much less power produced, but, depending on the price of gas versus the price of diesel, possibly for more money.

WHITE PINE

WHITE PINE is another cruiser with a workboat heritage. In general her hull is a "built-down" Maine lobsterboat. But I've made some changes due to weight distribution.

LCG in a traditional lobsterboat is just aft of amidships (station No. 5). This is achieved by pushing the engine forward of station 5 to balance fishing gear and fuel aft. So, the hull is shaped with the LCB just abaft station No. 5. Great! The working version floats level and on her lines at rest with a given load. But the less-than-optimum LCB is a compromise to deal with great variations in loading and speed.

WHITE PINE will never see such variations in load, so we can predict her speed within a small range. From full to empty tanks is a difference of 3,750 lbs, or about 1.5 knots. Her S/\sqrt{L} of 2.5 ($FN_{\nabla} = 1.7$) at 15 knots dictates an ideal LCB at station No. 5.7. This works out perfectly with her arrangement. There is plenty of room under the deckhouse sole to center the weight of the engine and tanks

close to the LCB. So, as tanks go from full to empty the LCG will remain unaffected. With this arrangement, I can relax about weights, because all the major ones are in the middle of the boat, and be pretty sure WHITE PINE will be a successful design.

As we discussed when looking at DOUGLAS FIR, VCG is also important, and this is where the "built-down" hull has an advantage. The built-down hull has filled-out garboards, instead of a solid narrow skeg, allowing the engine to be installed lower in the boat. The lower engine means the deckhouse can be lower, which is a plus in the aesthetics column. Of course, the filled-out garboard increases wetted surface, increasing drag due to skin friction.* So you take your choice: better looks and easier motion in a seaway, versus higher speed and somewhat better visibility from the helm.

SITKA SPRUCE

With a deadrise angle of 17° at the transom, SITKA SPRUCE is just barely a deep-V planing hull. (Today designers consider any boat with deadrise over 16° at the transom to be a deep-V.)

One of the first successful deep-Vs was MOPPIE, built in 1960. She had 24° of deadrise, was designed by C. Raymond Hunt, and maintained 23 mph through 9–10' seas and 30 knots of wind to win the Miami–Nassau race in eight hours. She was a radical boat at the time; other planing boats of the day had very shallow V-bottoms that became almost flat at the stern. MOPPIE's deadrise was almost constant her whole length, meeting the chine well above the

*However, the skeg-built boat may have more wetted surface, depending on the size of the skeg.

Planing Hull

SITKA SPRUCE

LOA	18'
LWL	15' 8"
Beam	7'
Draft hull	11 1/2"
Displacement	2,000 lbs
D/L	237
Power	outboard 70-130-hp
Top speed (with 70 hp)	28 knots
S/VL	7
FN∇	4.78
C _p	.75
B/L	.39

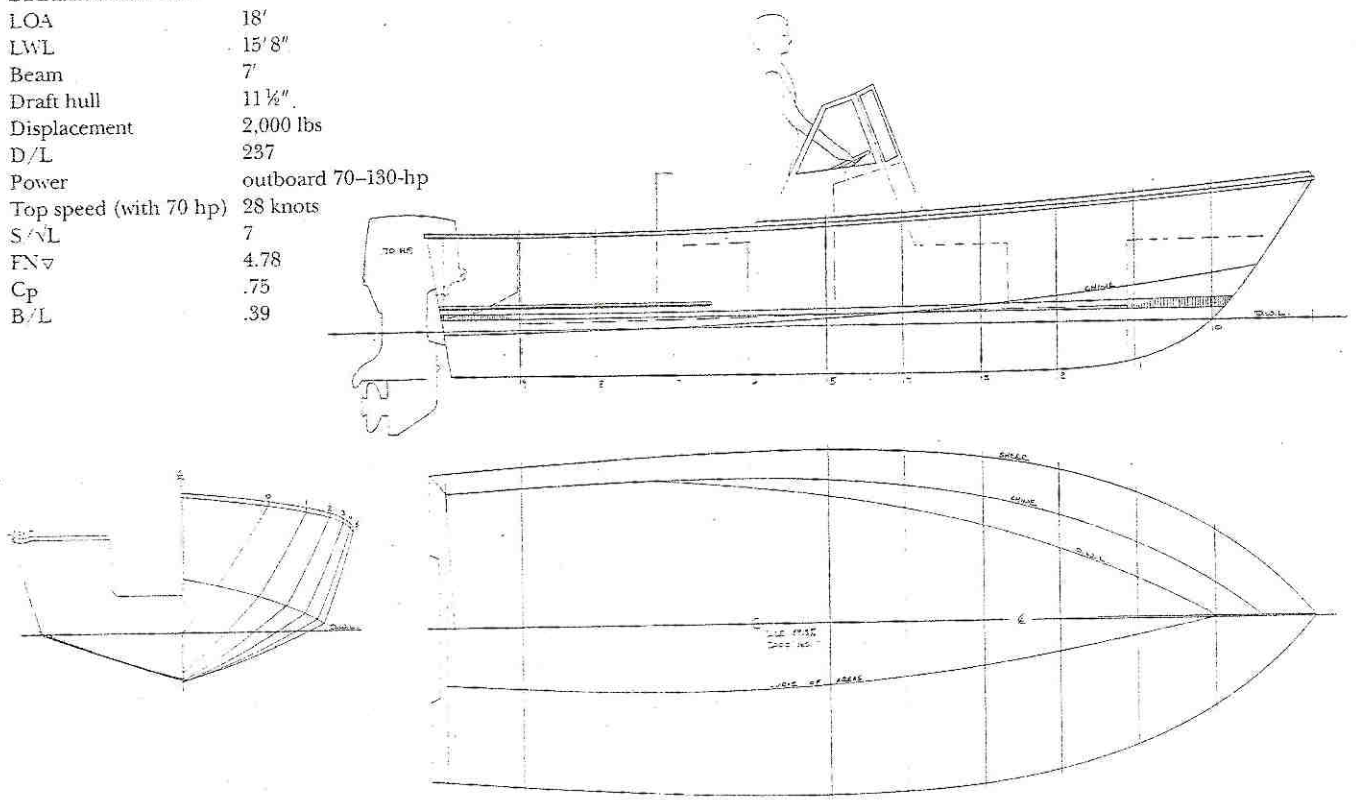

waterline, which made her tender at low speed or at rest. The narrow V shape also needed more power for a given speed than the flatter-bottomed boats. But by winning Miami-Nassau, breaking the old record by 32 minutes in truly rough conditions, MOPPIE established a whole new class of boat. SITKA SPRUCE and all her relatives are direct descendants of the Hunt deep-V.

The planing hull is supported almost totally by hydrodynamic forces (lift) created when the bottom strikes the water at an angle (trim) and a velocity (boat speed). The flatter the bottom, the more efficient it is as a lifting surface, and the faster the boat. But a flat-bottomed, high-speed boat will pound itself to bits in any amount of sea; it's also difficult to control, and the pounding is very hard on crew.

The acute deadrise of the early deep-Vs solved the pounding and handling problems of the shallow-V hulls, but they lacked the lift necessary to really get up and go. So, Mr. Hunt also came up with "deadrise angle compensators," the small horizontal strips seen on virtually all V-bottomed boats. He borrowed the idea from seaplanes. These appendages are now known as "lifting strakes," and provide lateral stability and flow separation, reducing frictional drag.

There is no published data I know of concerning the most efficient positioning of lifting strakes; designers try whatever they think might help the hull. We can see what the outer one is doing because it's exposed when the hull is up on plane; the inboard ones we're less sure about, though it seems a good idea to have them inboard

up forward, where deadrise increases. SITKA SPRUCE has two lifting strakes, one almost full length at 3/4 beam and parallel to the chine, and a short one further inboard running back to station No. 7. She also has a narrow horizontal chine flat.

One more neat thing about V-bottomed boats is they can be built of plywood, as SITKA SPRUCE is meant to be. A developable shape in plywood is not perfect for a small powerboat, but it's pretty good. If the boat has much beam, the bow becomes a bit full for my taste, but balanced against cost and ease of construction, it's a worthwhile trade.

SITKA SPRUCE is an outboard-powered fisherman. At a weight of 1,800 lbs, a 300-lb, 90-hp outboard motor will push her at 32 knots (top speed) and she'll cruise at 26 knots using about 56 hp. These large outboards are engineering marvels, but have ceased to be inexpensive. Luckily, there's always someone who needs next year's model and has to take a loss on last year's, and this makes SITKA SPRUCE more attainable for those with a winter's worth of weekends to hammer her together.

RED CEDAR

RED CEDAR is a family coastal cruiser. Her overall look is meant to be timeless, incorporating function rather than quickly dated stylishness.

Freeboard is high enough to keep the deck dry and provide reasonable interior space, but not as high as in modern boats with their ungainly top-heavy looks. The slight powderhorn to the sheer is a matter of taste; it also

Planing Hull

RED CEDAR

LOA	28'
LWL	25'10"
Beam	9'6"
Draft	17½"
Displacement @ ½ load	7,800 lbs
Fuel	175 gallons
D/L	201
Power	7.4-liter outdrive
	330 hp
Cruising speed	25 knots
S/√L	4.9
FN∇	3.36
C _p	.715
B/L	.34

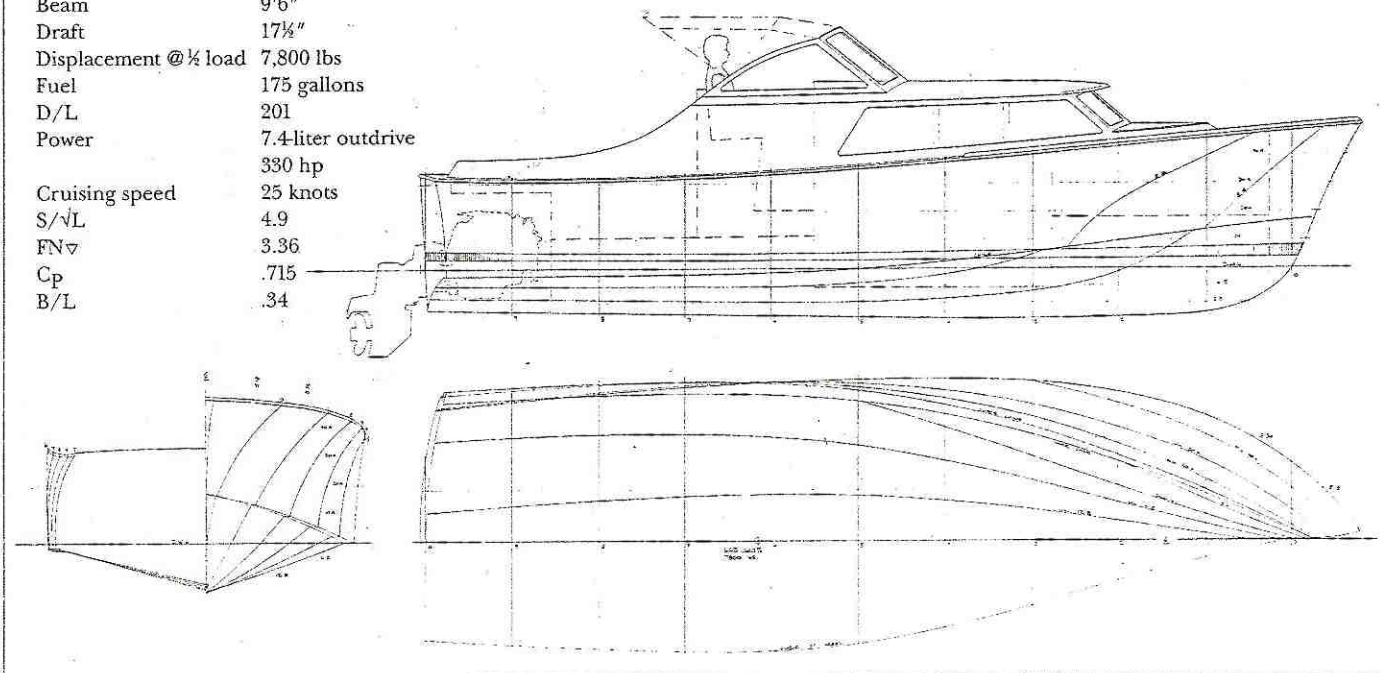

gets the deck a couple of inches higher from station Nos. 1 to 5—just the area where it can really add to interior space. This is also the area where increased freeboard helps throw off spray before it's blown back onto the windshield. And I think the powderhorn adds pizzazz to what can otherwise be a boring line.

This hull form, often called the modified-V, or variable-deadrise hull, is my favorite shape for a moderate-speed planing boat. It is a compromise, with fine, deep, forward sections, similar to the deep-V, but becoming much flatter and wider aft. RED CEDAR has 14° of deadrise at the transom, so we sacrifice the ability to blast off the tops of waves at 30+ knots. But we do have a hull that gets up on plane quickly and runs there economically. At a cruising speed of 26 knots, RED CEDAR needs about 1 hp for every 39 lbs of boat, whereas SITKA SPRUCE, with her deep-V hull, needs 1 hp for every 28 lbs of boat. Part of this economy is length: the longer a boat, the easier it is to push. RED CEDAR also has a lower B/L, .34, compared to .39 for SITKA SPRUCE. This eases her lines; note that the half-angle of entry for RED CEDAR's waterline is 17° versus 20° for SITKA SPRUCE's.

I have chosen a single large outdrive as RED CEDAR's propulsion system. Though there are many choices, I believe this to be the best from an efficiency standpoint (appendage drag of single leg), and an economy standpoint (only one engine to buy, install, build beds for, etc.). Efficiency is a funny thing: sometimes the installation of a smaller engine produces a faster boat by reducing weight and/or drag.

TEAK

TEAK is what I call a heavy deep-V. Her D/L of 224 makes her the heaviest planing boat in the group because of her

heavier engines, increased fuel load, and accommodations.

The large engines will make TEAK fast for her size. A top speed of 42 knots requires a pair of high-strung 600-hp diesels and waterjet drives. For a heavy commuting schedule, with the possibility of adverse conditions, she has a deep-V (18° deadrise at the transom) hull form designed to run at FN∇ 4.5, almost exactly halfway between RED CEDAR (FN∇ 3.4) and SITKA SPRUCE (FN∇ 4.78).

TEAK has a broken sheerline, similar to that of IRON-BARK, but unusual in express cruisers these days. I believe its disappearance is at least partly due to the inability of computer software to deal with discontinuity in lines. It would be usual for a boat of this type to have a flying bridge atop the deckhouse, but at 40+ knots, the windage penalty is just too great.

My preliminary calculations show that this hull, at 20,700 lbs displacement, requires about 1,100 hp to achieve 42 knots. That's calculated based on a propulsion efficiency of .5. Meaning, to push the boat at target cruising speed, I'd double the basic power needed to overcome bare hull resistance. This is to account for added drag from windage, bottom fouling, side wetting (spray), sea state, appendage drag (if any), and power train losses. Propulsive efficiency goes up for the jet drive above about 35 knots because there is no appendage drag, but drops as compared to propeller drives below that speed. So, jet drives make sense for TEAK's 42 knots, but a 30-knot boat needs a reason other than efficiency to justify waterjets.

I have chosen twin Daytona 600-hp diesels coupled to Hamilton 321 waterjets as power for TEAK. This leaves some reserve to handle the weight increases that surely lie beyond the preliminary design stage.

Planing Hull

TEAK

LOA	38'
LWL	34'7"
Beam	13'
Draft hull	2'2"
Displacement @ ½ load	21,000 lbs
D/L	224
Power	Twin Daytona DME-7S 600 hp (each)
Top speed	42 knots
S/√L	6.8
FN∇	4.53
C _p	.711
B/L	.34

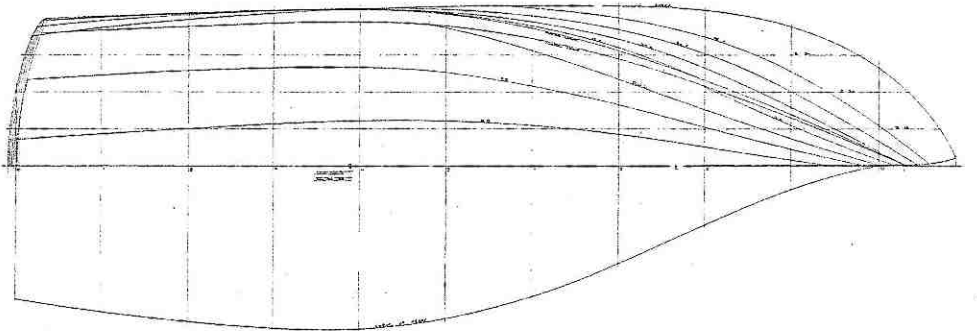
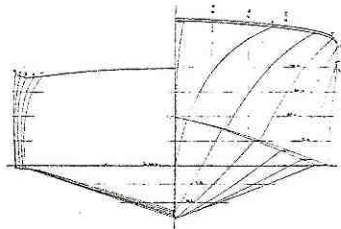
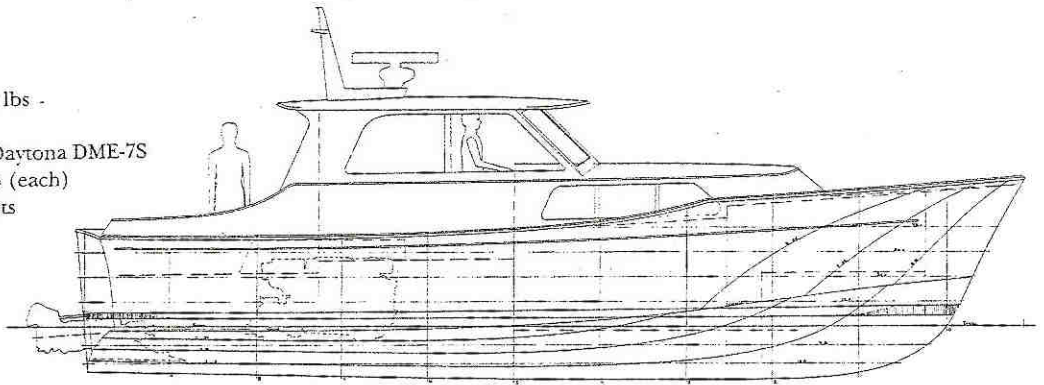

Planing Hull

MAHOGANY

LOA	28' 5 1/2"
LWL	23'9"
Beam	7'6"
Draft	20' 1/2"
Displacement @ ½ load	5,700 lbs
Fuel	150 gallons
D/L	190
Power	Twin 7.4-liter Mercruiser Outdrives 330 hp (each)
Top speed	65 knots
S/√L	12.5
FN∇	9.5
B/L	.264

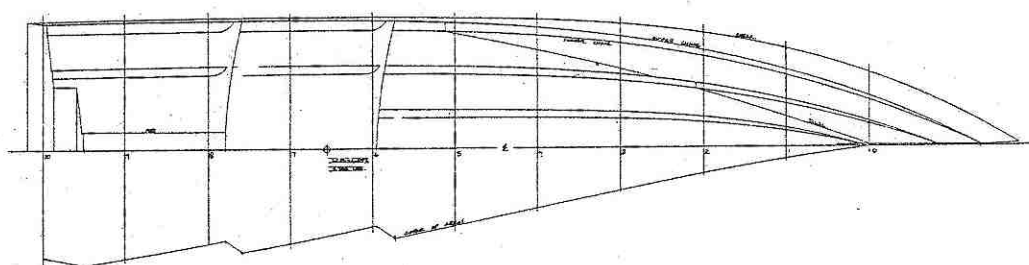
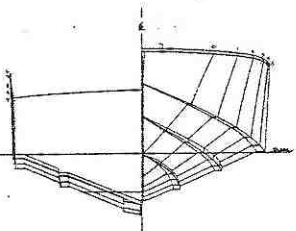
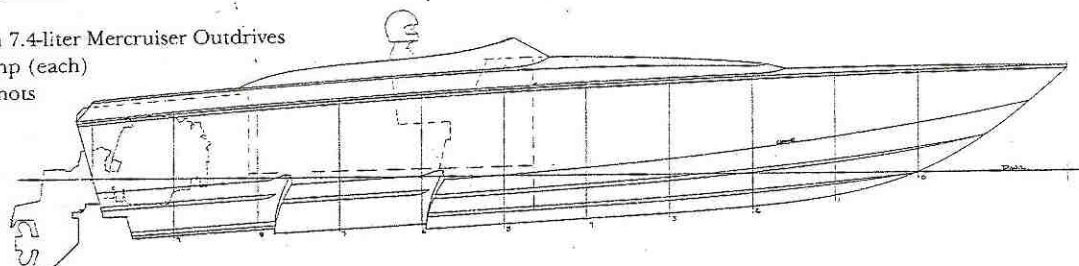

MAHOGANY

Currently, the fastest offshore monohulls in the world all have bottoms with two transverse steps. So, I'll describe MAHOGANY's hull as a state-of-the-art raceboat. Actually, which type of boat is ultimately fastest depends on sea state; step-hull catamarans are fastest in flat water, but the monohulls take the lead in rough stuff.

MAHOGANY's two steps, 23° deadrise, and small pad aft all help to produce maximum speed. But this speed comes at a price. Because we've used almost every trick in the book to break water clear of her hull and reduce frictional drag, MAHOGANY at speed will need a delicate and deft hand at the controls.

The step hull has been around for a long time. A transverse discontinuity appears in what is generally acknowledged as the first planing-hull patent, that of the Reverend C.M. Ramus in 1872. Though no working vessel resulted from Reverend Ramus's work, step-hull "Hydroplanes" started appearing soon after 1900. Development continued until about the Second World War, when most of the world's navies decided against step hulls for motor torpedo boats. Step hulls had a reputation for hard riding (because of flat sections aft of the step), were prone to break (bottom discontinuity is difficult to engineer in wood), and had trim problems resulting from major shifts of LCG after a torpedo launch. So, the step hull fell from the public eye, and little development was attempted until quite recently. We now see steps that work on offshore racers—both monohulls and catamarans, and they have appeared on a number of production "muscle boats," as well.

The pad is a narrow section of hull, with much less deadrise, running along the centerline from the transom to the aftmost step. The pad's low deadrise creates tremendous lift for its area, and it's the last portion of the hull to leave the water and first to re-enter. Some say it cushions re-entry. At planing speeds, the boat rides on this pad and the portion of hull just ahead of the forward step. This makes the boat longitudinally stable but still flighty in comparison to the regular deep-V.

Power for MAHOGANY is twin 7.4-liter MerCruiser outdrives of 330 hp each. It will take about 1 hp for each 8.4 lbs of boat, or 595 hp to push MAHOGANY at 65 knots.

I hope the preceding discussion has illustrated that a boat's function is the overriding design requirement that all other factors must bow to. Most boats perform multiple tasks, so they must be adaptable to various functions.

Are the boats presented here "good" designs? They are if they accomplish what is required by the owner, and if they are pleasing to the eye. Technically they are within acceptable norms. They are pleasing to my biased eye. You decide! 

Tad Roberts grew up in British Columbia drawing boats and working with his father, who was a logger and then owned several tugboats. They worked in the woods, did log towing and salvage, and had a small sawmill. Tad operated a fishpacker, dove for abalone, and fished for halibut and tuna from a sailing vessel. A self-taught designer, he did a number of fishboat designs in B.C. before moving to Maine in 1986. He has worked with Bruce King Yacht Design in Newcastle, Maine, for the past 10 years.

For more information on these designs, contact the author at 248 Atkins Rd., Jefferson, ME 04548; 207-549-5663.